

# Arrive AirPoint™ 1011-BYMG

Media Collaboration Gateway with Wireless BYOD  
Model AAP-1011-BYMG



Presenting AirPoint™ 1011-BYMG a universal wireless media presentation gateway product that supports Apple AirPlay, WiFi Miracast and Intel WiDi on the same integrated platform. AAP-1011-BYMG provides :

- Wireless screen mirroring for BYOD presentations.
- Does not require any downloads to be made to personal devices as applications or programs.
- Does not require dongles or other devices to be connected to the user's WiFi capable presentation device.

These capabilities are packaged in one user-friendly appliance interface which can be mounted under the table or on a wall.

Our single AIO appliance delivers a powerful and efficient in-room wireless collaboration experience for huddle rooms, small meeting rooms, classrooms and hotel guest rooms.

Arrive's AirPoint™ product line marks the industry's first generation of universally integrated devices - supporting the most commonly used wireless video connectivity platforms in a single device. This positions Arrive's AirPoint™ as the most innovative and cost effective wireless video interface in the industry.

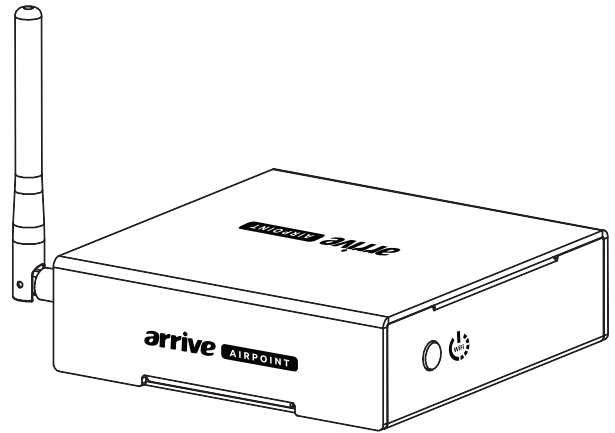

AAP-1011-BYMG



## Key Features

### Universal Wireless BYOD

Built-in universal wireless media receiver for BYODs that support Apple Airplay and WiFi Miracast wireless screen mirroring.

- Enable wireless screen mirroring one at a time from wireless connected iPad, iPhone, iPod devices which support Apple AirPlay. Connect Android tablets and smartphones, Samsung Galaxy smartphones and tablets, and Windows 8.1/10 laptops and tablets seamlessly using WiFi Miracast. Connect Intel WiDi devices to the AAP-1011-BYMG.
- Transmit wireless Audio and Video sync and play back.
- Eliminates the need for client applications to be downloaded on the users personal Apple iOS, Android 4+ and Windows 8.1/10 OS devices
- Eliminates the need for dongles, HDMI nodes or break-out USB senders to be connected and disconnected each time



## Hardware

### Processing

**Software Application** Embedded Arrive AirPoint™ wireless video processing application with native support of Apple® Airplay, Miracast™ screen mirroring and Intel WiDi. Manages SSID broadcast and wireless set-up.

**WiFi Built-in** 2.4 Ghz 802.11n capable. Low coverage radius to avoid spill-overs

**Wireless BYOD** Simply connect and present with integrated Apple® AirPlay® (Tested till version iOS 10.0), and WiFi Miracast capability. Connect via WiFi LAN or directly to the Arrive AirPoint™ wireless gateway. Does not require insertion of external dongles or initiation of any proprietary client software on compatible iOS / Android / Windows 8.1/10 devices.

Universal Wireless BYOD capable:



Miracast™



### User Side Panel A Input / Output Connections

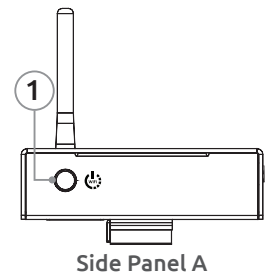
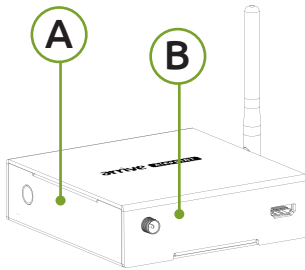

#### Side Panel

- 1 Wireless Reset Button (Note: The wireless reset button's position may vary)

### Panel B Back Input / Output Connections

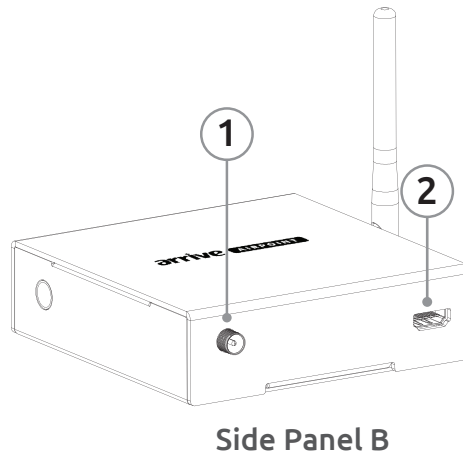

Side Panel B

#### Back I/O Panel

- |   |          |  |
|---|----------|--|
| 1 | DC Input | Use with DC adapter supplied with the system   |
| 2 | HDMI OUT | HDMI output supports 1080p display resolution. |

### Frame / Case and Mounting

- |              |  |
|--------------|--|
| Frame/Case   | Brushed Aluminum top cover with metal powder coated body |
| Color        | Black  |
| Mounting     | Wall Mount, can also be placed under tables or shelves   |
| Mounting Kit | Mounting kit included with installation instructions     |

### Included Cables and Hardware

- 1 x 5V - 2A power adaptor and cable
- Mounting Bracket

## SPECIFICATIONS

Arrive AirPoint™ - Media Collaboration Gateway with Wireless BYOD

Model AAP-1011-BYMG

### Operating requirements

Power requirements	Input DC 5V 2Amp
Operating temperature	5 to 30°C (23 - 86 °F)
Operating Position	Horizontal
Storage temperature	5-35°C (23 - 95 °F)
Operating Humidity	10-55%

### Dimensions

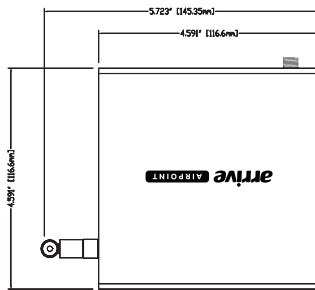

TOP VIEW

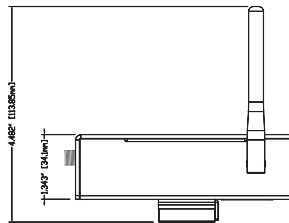

RIGHT VIEW

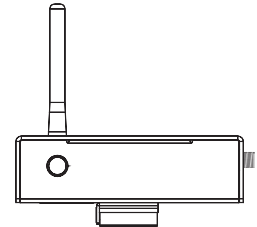

LEFT VIEW

Unit dimension 4.591" W x 1.343"H x 4.591" D (11.66 x 3.41 x 11.66cm)

### Certification and compliance

Regulatory certification	FCC-Class A, CE
Environmental compliance	RoHS, WEEE

### Purchasing information

Model No	AAP-1011-BYMG
Description	Arrive AirPoint™ 1011 BYMG - Media Collaboration Gateway with Wireless BYOD
SKU#	AAP-1011-001-001
Warranty Information	All Arrive Peripherals ship with a standard limited 12 months first user warranty. Please refer to Ver. SLHW-P-0101-15 - visit <a href="http://carepoint.arrivesys.com/warranty">carepoint.arrivesys.com/warranty</a> for updated information on warranty.